



Grass Trimmer

Operator's Manual

MODELS GT-251E

WARNING  **DANGER**



The muffler or catalytic muffler and surrounding cover may become extremely hot.

Always keep clear of exhaust and muffler area, otherwise serious personal injury may occur.



WARNING



The engine exhaust from this product contains chemicals known to the State of California to cause cancer, birth defects or other reproductive harm.



WARNING  **DANGER**

Read rules for safe operation and instructions carefully. ECHO provides an Operator's Manual and a Safety Manual. Both must be read and understood for proper and safe operation.

INTRODUCTION

Welcome to the ECHO family. This ECHO product was designed and manufactured to provide long life and on-the-job dependability. Read and understand this manual and the SAFETY MANUAL you found in the same package. You will find both easy to use and full of helpful operations tips and SAFETY messages.

THE OPERATOR'S MANUAL

Read and understand this manual before operation. Keep it in a safe place for future reference. It contains specifications and information for operation, starting, stopping, maintenance, storage, and assembly specific to this product.

THE SAFETY MANUAL

Read and understand this manual before operation. Keep it in a safe place for future reference. It explains possible hazards involved with the use of Grass Trimmers and Brush cutters and what measures you should take to make their use safer.

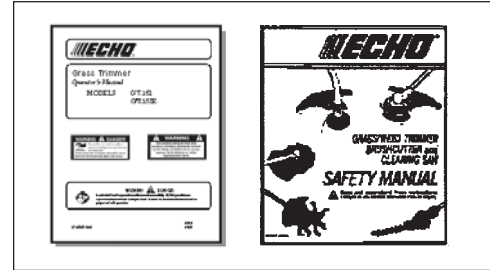

TABLE OF CONTENTS

Introduction	2	Maintenance	15
- The Operator's Manual	2	- Skill Levels	15
- The Safety Manual	2	- Maintenance Intervals	15
Safety	3	- Air Filter	16
- Manual Safety Symbols and Important Information ...	3	- Fuel Filter	16
- International Symbols	3	- Spark Plug	17
- Personal Conditions and Safety Equipment	3	- Cooling System	17
- Equipment	6	- Exhaust System	18
Emission Control	6	- Carburetor Adjustment	19
Description	7	- Lubrication	21
Contents	9	Troubleshooting	22
Assembly	10	Storage	23
- Plastic Shield Installation	10	Specifications	24
- Nylon Line Head Installation	10	Servicing Information	28
- Nylon Line Installation	11	- Parts/Serial Number	28
- Front (Loop) Handle	11	- Service	28
Operation	12	- ECHO Consumer Product Support	28
- Fuel	12	- Warranty Card	28
- Starting Cold Engine	13	- Additional or Replacement Manuals	28
- Starting Warm Engine	14		
- Stopping Engine	14		

Specifications, descriptions and illustrative material in this literature are as accurate as known at the time of publication, but are subject to change without notice. Illustrations may include optional equipment and accessories, and may not include all standard equipment.

SAFETY

MANUAL SAFETY SYMBOLS AND IMPORTANT INFORMATION

Throughout this manual and on the product itself, you will find safety alerts and helpful informational messages preceded by symbols or key words. The following is an explanation of those symbols and key words and what they mean to you.



This symbol accompanied by the words **WARNING** and **DANGER** calls attention to an act or condition that can lead to serious personal injury to operator and bystanders.



The circle with the slash symbol means whatever is shown within the circle is prohibited.













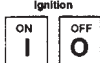

IMPORTANT **NOTE**

IMPORTANT The enclosed message provides information necessary for the protection of the unit.

NOTE This enclosed message provides tips for use, care and maintenance of the unit.

INTERNATIONAL SYMBOLS

SYMBOL FORM/ SHAPE	SYMBOL DESCRIPTION/APPLICATION	SYMBOL FORM/ SHAPE	SYMBOL DESCRIPTION/APPLICATION
	Read and understand Operator's Manual.		FUEL AND OIL MIXTURE
	WEAR EYES, EARS AND HEAD PROTECTION		FINGER SEVERING
	HOT SURFACE		WEAR SLIP RESISTANT FOOT WEAR.
	WEAR HAND AND FOOT PROTECTION		DO NOT SMOKE NEAR FUEL.
	SAFETY/ALERT		DO NOT ALLOW FLAMES OR SPARKS NEAR FUEL.
		KEEP BYSTANDERS AND HELPERS AWAY 15 M (50 FT.).	

SYMBOL FORM/ SHAPE	SYMBOL DESCRIPTION/APPLICATION	SYMBOL FORM/ SHAPE	SYMBOL DESCRIPTION/APPLICATION
	PRIMER BULB		EMERGENCY STOP
	DO NOT EXCEED 10,000 RPM.		IGNITION ON/OFF
	BEWARE - THROWN, RICOCHET OBJECTS		CARBURETOR ADJUSTMENT - HIGH SPEED MIXTURE
	CARBURETOR ADJUSTMENT - IDLE SPEED		CARBURETOR ADJUSTMENT - LOW SPEED MIXTURE
	CHOKE CONTROL "COLD START" POSITION (CHOKE CLOSED)		CHOKE CONTROL "RUN" POSITION (CHOKE OPEN)
	DO NOT USE BLADES. STRING LINE ONLY		BEWARE - THROWN, RICOCHET OBJECTS

PERSONAL CONDITION AND SAFETY EQUIPMENT

WARNING  **DANGER**

Trimmer/Brush Cutter users risk injury to themselves and others if the trimmer/brush cutter is used improperly and or safety precautions are not followed. Proper clothing and safety gear must be worn when operating a trimmer.

Physical Condition

Your judgment and physical dexterity may not be good:

- if you are tired or sick,
- if you are taking medication,
- if you have taken alcohol or drugs.

Operate unit only if you are physically and mentally well.

Eye Protection

Wear eye protection that meets ANSI Z87.1 or CE requirements whenever you operate the unit.

Hand Protection

Wear no-slip, heavy-duty work gloves to improve your grip on the handles. Gloves also reduce the transmission of machine vibration to your hands.

Hearing Protection

ECHO recommends wearing hearing protection whenever unit is used.

Proper Clothing

Wear snug fitting, durable clothing;

- Pants should have long legs, shirts with long sleeves.
- DONOT WEAR SHORTS,
- DONOT WEAR TIES, SCARFS, JEWELRY.

Wear protective hair covering to contain long hair.

Wear sturdy work shoes with nonskid soles;

- DONOT WEAR OPENTOED SHOES,
- DONOT OPERATE UNIT BAREFOOTED.

Hot Humid Weather

Heavy protective clothing can increase operator fatigue which may lead to heat stroke. Schedule heavy work for early morning or late afternoon hours when temperatures are cooler.

Vibration and Cold --

It is believed that a condition called Raynaud's Phenomenon, which affects the fingers of certain individuals, may be brought about by exposure to vibration and cold. Exposure to vibration and cold may cause tingling and burning sensations, followed by loss of color and numbness in the fingers. The following precautions are strongly recommended, because the minimum exposure which might trigger the ailment is unknown.

- Keep your body warm, especially the head, neck, feet, ankles, hands, and wrists.
- Maintain good blood circulation by performing vigorous arm exercises during frequent work breaks, and also by not smoking.
- Limit the hours of operation. Try to fill each day with jobs where operating the unit or other hand-held power equipment is not required.
- If you experience discomfort, redness, and swelling of the fingers followed by whitening and loss of feeling, consult your physician before further exposing yourself to cold and vibration.





Repetitive Stress Injuries --

It is believed that overusing the muscles and tendons of the fingers, hands, arms, and shoulders may cause soreness, swelling, numbness, weakness, and extreme pain in those areas. Certain repetitive hand activities may put you at a high risk for developing a Repetitive Stress Injury (RSI). An extreme RSI condition is Carpal Tunnel Syndrome (CTS), which could occur when your wrist swells and squeezes a vital nerve that runs through the area. Some believe that prolonged exposure to vibration may contribute to CTS. CTS can cause severe pain for months or even years.

To reduce the risk of RSI/CTS, do the following:

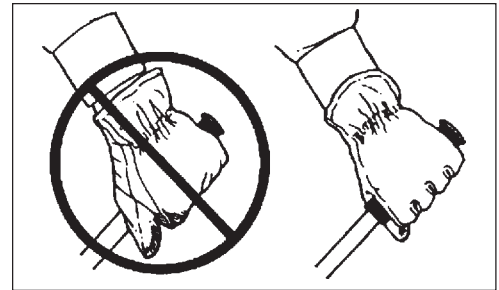
- Avoid using your wrist in a bent, extended, or twisted position. Instead try to maintain a straight wrist position. Also, when grasping, use your whole hand, not just the thumb and index finger.
- Take periodic breaks to minimize repetition and rest your hands.
- Reduce the speed and force with which you do the repetitive movement.
- Do exercises to strengthen the hand and arm muscles.
- Immediately stop using all power equipment and consult a doctor if you feel tingling, numbness, or pain in the fingers, hands, wrists, or arms. The sooner RSI/CTS is diagnosed, the more likely permanent nerve and muscle damage can be prevented.



WARNING  **DANGER**

Do not operate this product indoors or in inadequately ventilated areas. Engine exhaust contains poisonous emissions and can cause serious injury or death.

Read the Manuals

- Provide all users of this equipment with the Operator's Manual and Safety Manual for instructions on Safe Operation.

Clear the Work Area

- Spectators and fellow workers must be warned, and children and animals prevented from coming nearer than 15 m (50 ft.) while the unit is in use.

Keep a Firm Grip

- Hold the front and rear handles with both hands, with thumbs and fingers encircling the handles.

Keep a Solid Stance

- Maintain footing and balance at all times. Do not stand on slippery, uneven or unstable surfaces. Do not work in odd positions or on ladders. Do not over reach.

Avoid Hot Surfaces

- Keep exhaust area clear of flammable debris. Avoid contact during and immediately after operation.

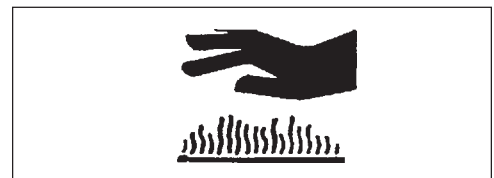

EQUIPMENT

WARNING DANGER

Use only ECHO approved attachments. Serious injury may result from the use of a non approved attachment combination. ECHO, INC. will not be responsible for the failure of cutting devices, attachments or accessories which have not been tested and approved by ECHO. Read and comply with all safety instructions listed in this manual and safety manual.

- Check unit for loose/missing nuts, bolts and screws. Tighten and/or replace as needed.
- Inspect fuel lines, tank and area around carburetor for fuel leaks. DO NOT operate unit if leaks are found.
- Inspect shield for damage and ensure that the cut-off knife is securely in place. Replace if either is damaged or missing.
- Check that the cutting attachment is firmly attached and in safe operating condition.
- Check that front (loop) handle and optional shoulder/waist harness are adjusted for safe, comfortable operation. See Assembly for proper adjustment.
- Have repairs done only by an authorized ECHO Service Dealer.

EMISSION CONTROL

EPA Phase 2

The emission control system for this engine is EM (Engine Modification).

IMPORTANT ENGINE INFORMATION

ENGINE FAMILY: 5EHXS.0254ED DISPLACEMENT: 25.4 cc

EMISSION COMPLIANCE PERIOD : 300 HRS.

THIS ENGINE MEETS U.S. EPA PHASE 2 EMISSION REGULATIONS FOR SMALL NONROAD ENGINES. REFER TO OWNER'S MANUAL FOR MAINTENANCE SPECIFICATIONS AND ADJUSTMENTS.



KIORITZ CORP. ***

Emission Control Label located on Engine (EXAMPLE ONLY, information on label varies by FAMILY).

PRODUCT EMISSION DURABILITY

The 300 hour emission durability compliance period is the time span selected by the manufacturer certifying the engine emissions output meets applicable emissions regulations, provided that approved maintenance procedures are followed as listed in the Maintenance Section of this manual.

DESCRIPTION

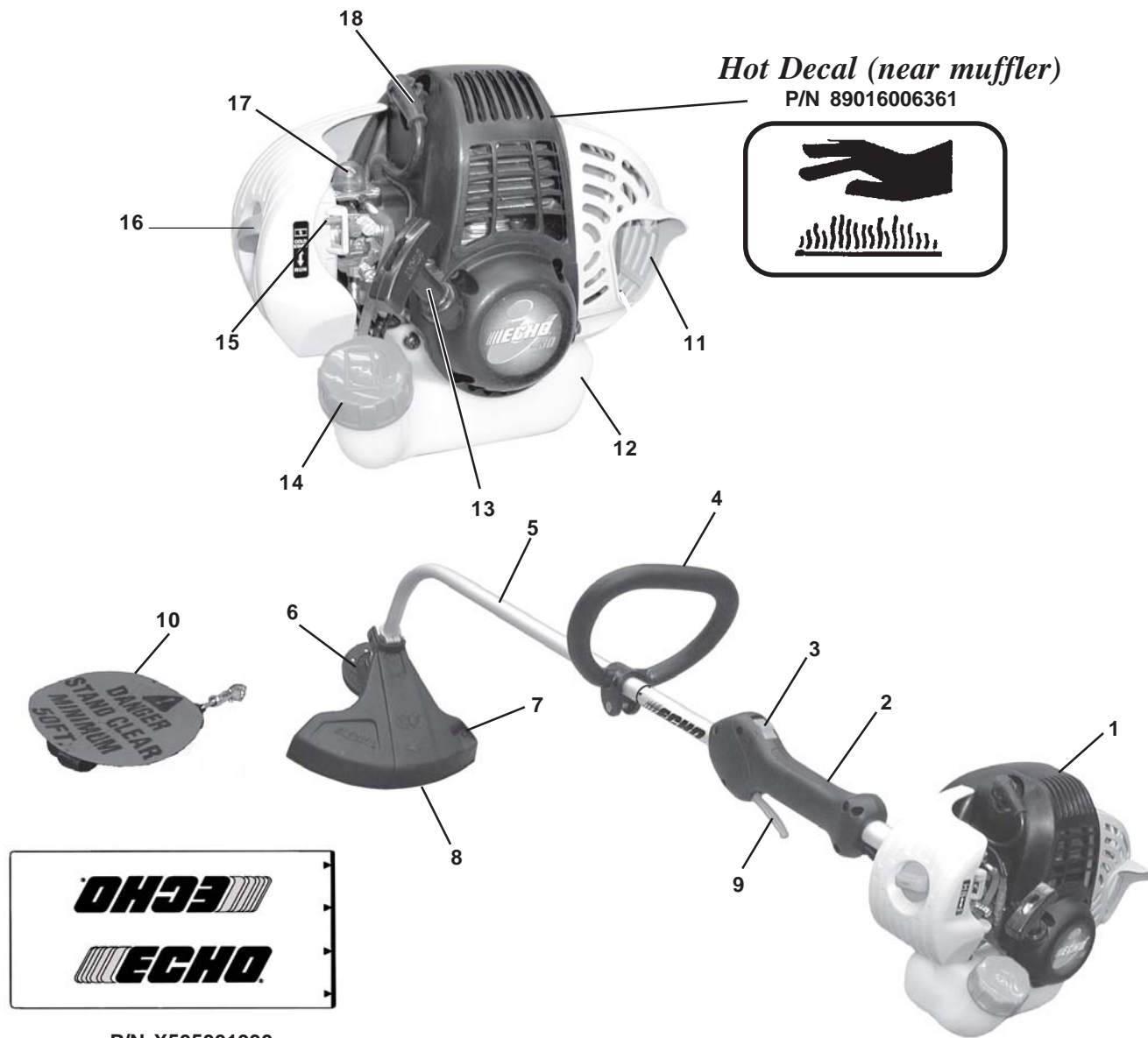

Locate these safety decals on your unit. Make sure the decals are legible and that you understand and follow the instructions on them. If a decal cannot be read, a new one can be ordered from your ECHO dealer. See PARTS ORDERING instructions for specific information.



Shaft Decal

P/N 89031748731

	<p>WARNING ⚠ DANGER</p> <p>1 This unit can be dangerous and cause serious injury if improperly used. To reduce injury risk to operator, helpers and bystanders, read and understand the Operators and Safety Manuals.</p> <p>2 Blindness can occur from objects that are thrown or ricochet even with shield in place. Operators, helpers and by-standers must wear eye protection, ANSI Z87.1 approved.</p>	<p>'GT' UNITS</p>	<p>3 Always wear hearing protection when operating unit.</p> <p>4 Prevent accidental contact with unit and any cutting attachment. Maintain a 50 ft. (15 m) radius, DANGER ZONE surrounding the operator. ONLY the operator, dressed in proper protective clothing should be in the DANGER ZONE.</p> <p>5 DO NOT INSTALL METAL BLADES ON GT (GRASS TRIMMERS) MODELS.</p>	<p>6 Cutting attachment does not stop immediately after releasing throttle. Keep hands and feet clear of blade/cutting attachment unless engine is shut off and cutting attachment is not moving.</p> <p>7 Do not remove shields, modify the unit or install attachments or parts not approved by ECHO. Approved attachment information and replacement Operators and Safety Manuals are available from your ECHO dealer or by writing: ECHO INCORPORATED, 400 Oakwood Rd., Lake Zurich, IL 60047.</p>	
	<p>ATTENTION ⚠ DANGER</p> <p>1 Cet appareil peut être dangereux et causer des blessures graves s'il est mal employé. Pour réduire les risques de blessures à l'opérateur, aux assistants et aux spectateurs, lire les manuels de l'opérateur et de sécurité pour en comprendre la portée.</p> <p>2 Les objets projetés par l'appareil ou par ricochet, peuvent provoquer la cécité. Les opérateurs, les assistants et les spectateurs doivent porter des lunettes de protection ANSI 87.1 approuvées.</p>	<p>UNITÉS 'GT'</p>	<p>3 Toujours porter une protection auditive pendant l'utilisation de l'appareil.</p> <p>4 Prévenir tout contact accidentel avec l'appareil et les accessoires de coupe. Maintenir une ZONE DE DANGER de 50 pieds (15 m) autour de l'opérateur. SEUL l'opérateur portant les vêtements protecteurs appropriés devrait être dans la ZONE DE DANGER.</p> <p>5 NE PAS INSTALLER LES COUPEAUX DE METAL SUR LES MODELES GT (COUPE-HERBE).</p>	<p>6 L'accessoire de coupe ne s'arrête pas immédiatement après avoir relâché la gâchette. Garder les mains et les pieds éloignés de l'accessoire de coupe, à moins que le moteur ne soit arrêté et que l'accessoire ne bouge plus.</p> <p>7 Ne pas enlever les protecteurs, modifier l'appareil ou installer des accessoires qui ne sont pas approuvés par ECHO. Des renseignements sur les accessoires ECHO approuvés et les pièces de rechange se trouvent dans les manuels de l'opérateur et de sécurité que vous pouvez obtenir auprès de votre marchand ECHO ou en écrivant à: ECHO INCORPORATED, 400 Oakwood Rd., Lake Zurich, IL 60047.</p>	<p>89031748731</p>

1. **POWER HEAD** - Factory Assembled to the Drive Shaft assembly. Includes the Engine, Clutch, Fuel System, Ignition System and Recoil Starter.
2. **GRIP** - Rear (right hand) handle.
3. **STOP SWITCH** - "SLIDE SWITCH" mounted on top of the Throttle Trigger Housing. Move switch FORWARD to RUN, BACK to STOP.
4. **FRONT HANDLE** - The Front (loop) handle is factory assembled to the Drive Shaft assembly but must be repositioned for proper cutting attitude and operator comfort.
5. **DRIVE SHAFT ASSEMBLY** - Factory Assembled to the Power Head. Includes the Rear (right hand) Handle Assembly, Bearing Housing Assembly, Throttle Trigger, Front (loop, left hand) Handle Assembly, Flexible Drive Cable and Safety Decals.
6. **RAPID LOADER™ HEAD** - Contains replaceable nylon trimming lines.
7. **CUT-OFF KNIFE** - Trims line to the correct length (5 in.). If trimmer is operated without a cut-off knife the line will become too long - more than (5 in.) - the operating speed will slow, the engine overheat and performance will suffer.
8. **DEBRIS SHIELD ASSEMBLY** - Included in plastic bag (co-pack). **MUST** be installed on unit before use, see Assembly Instructions. Shield assembly includes the Cut-Off Knife and Safety Decal. Mounts on the Bearing Housing Assembly just above the cutting attachment. Helps protect the operator by deflecting debris produced during the trimming operation.
9. **THROTTLE TRIGGER** - Spring loaded to return to idle when released. During acceleration, press trigger gradually for best operating technique.
10. **SHOULDER HARNESS** - Optional (P/N 99944200201). An adjustable strap that suspends the unit from the operator.
11. **SPARK ARRESTOR - CATALYTIC MUFFLER/MUFFLER** - The muffler or catalytic muffler controls exhaust noise and emission. The spark arrestor screen prevents hot, glowing particles of carbon from leaving the muffler. Keep exhaust area clear of flammable debris.
12. **FUEL TANK** - Contains fuel and fuel filter.
13. **I-30 RECOIL STARTER/HANDLE** - i30 spring-assisted recoil starter requires 30% less pulling force than standard recoil starter. Pull handle slowly until starter engages, then quickly and firmly. When engine starts, return handle slowly. **DO NOT** let handle snap back or damage to unit will occur.
14. **FUEL TANK CAP** - Cover and seals fuel tank opening.
15. **CHOKE** - Located at the rear of the air cleaner housing. Move choke lever to "Cold Start" () to close choke for cold starting. Move choke lever to "Run" () position to open choke.
16. **AIR CLEANER** - Contains replaceable filter element.
17. **PURGE BULB** - Pumping purge bulb before starting engine draws fresh fuel from the fuel tank, purging air from the carburetor. Pump purge bulb until fuel is visible and flows freely in the clear fuel tank return line. Pump purge bulb an additional 4 or 5 times.
18. **SPARK PLUG** - Provides spark to ignite fuel mixture.

CONTENTS

The ECHO product you purchased has been partially assembled for your convenience. Due to packaging restrictions, installation of the plastic debris shield, nylon line head, and positioning of the front handle are necessary.

After opening the carton, check for damage. Immediately notify your retailer or ECHO Dealer of damaged or missing parts. Use the contents list to check for missing parts.

* Some units may be factory pre-assembled. No assembly tools are needed and the nylon line head, plastic debris shield, and mounting hardware, shown in the contents list, are pre-assembled to the unit. Only the front handle may need to be re-positioned for comfortable operation.

- _____ - Trimmer Assembly:
- _____ - Power Head
- _____ - Drive Shaft Assembly
- _____ - Plastic Bag (Co-Pack)
- _____ - Operator's Manual
- _____ - Safety Manual
- _____ - Warranty Card & Limited Warranty
- _____ - Locking Tool, P/N 89751801131 (head locking tool)
- _____ - Safety Glasses
- _____ - Echo Power Blend™ 2-stroke oil sample
- _____ - 12 pcs. 8 in. x .080 Pre-cut Nylon Line

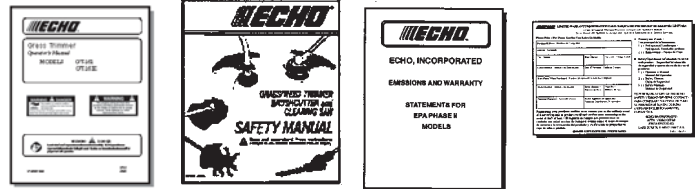

- * _____ - Rapid Loader™ 2-line Head
- * _____ - Shield Assembly
- * _____ - Line Head Mounting Hardware:
- * _____ - 3/8-24 Locknut
- * _____ - Small Washer
- * _____ - Large Washer
- * _____ - Locking Tool, P/N 89751801131 (wrench handle)
- * _____ - Wrench 17 x 14.5, P/N X602000031

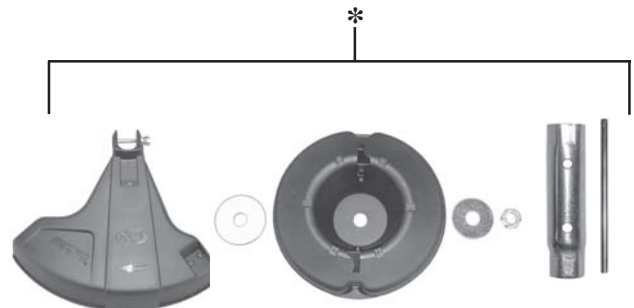

ASSEMBLY

Tools Required: Locking Tools (2), Wrench 17 x 14.5 (9/16 in.)

Parts Required: Rapid Loader™ Head, Large washer, Small washer, 3/8-24 Locknut, (2) Pre-cut Nylon Line 8 in. x .080 in., Plastic Shield Assembly

WARNING DANGER

Cut-off knife on debris shield has sharp edges. Avoid contact when installing or removing line head.



PLASTIC SHIELD INSTALLATION

1. Remove cardboard tube.
2. Remove wing nut (C), washer (B), and bolt (A).
3. Snap the shield over the bearing housing.
4. Install bolt (A), washer (B) and wing nut (C).

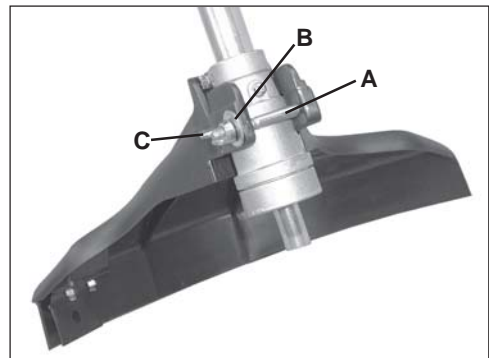

NYLON LINE HEAD INSTALLATION

1. Remove plastic threaded shaft sleeve from threaded PTO shaft.
2. Align locating hole in upper plate with hole in bearing housing and insert 5 mm (3/16 in.) diameter locking tool (A).
3. Place large washer (B) then line head (C) on threaded shaft, followed by small metal washer (D) and locknut (E).
4. Install 3/8-24 locknut using 14.5 mm (9/16 in.) wrench. Turn locknut clockwise, and tighten securely.

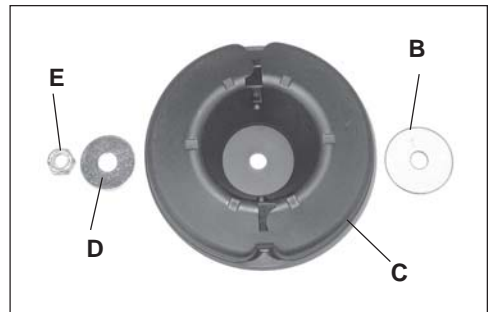

IMPORTANT

Remember to remove the locking tool.

NYLON LINE INSTALLATION

1. Shut engine off. Lay unit on the ground with head assembly up.
2. Remove old nylon line through center recess of head.
3. Thread new lines through outside holes (A) in housing until ends meet in center of recess.

NOTE

Insert cutting line ends to center of head recess to insure easy removal of used lines.

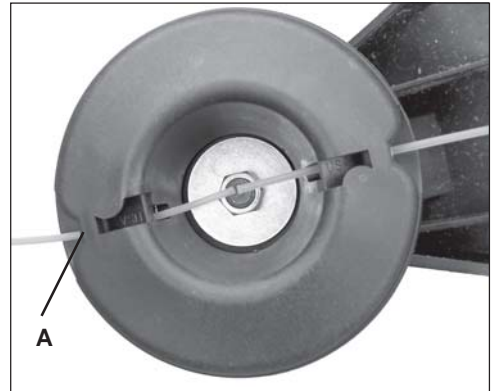

FRONT (LOOP) HANDLE

NOTE

Label shows minimum spacing for front handle location.

NOTE

Front handle is pre-installed. Re-positioning and tightening is all that is required.

1. Position front handle (A) in comfortable operating position and tighten wing nut (B). The cutting attachment should be 5-7.5 cm (2-3 in.) above the ground and as level as possible.

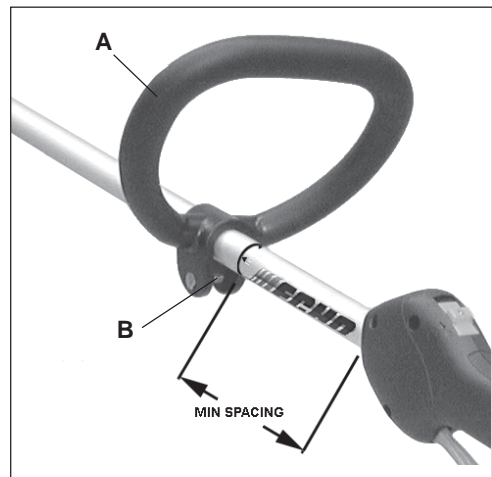

OPERATION

NOTICE: Use of unmixed, improperly mixed, or fuel older than 90 days, (stale fuel), may cause hard starting, poor performance, or severe engine damage and void the product warranty. Read and follow instructions in the Storage section of this manual.

FUEL

Fuel Requirements

Gasoline - Use 89 Octane [R+M/2] (mid grade or higher) gasoline known to be good quality. Gasoline may contain up to 15% MTBE (methyl tertiary-butyl ether). Gasohol containing methyl (wood) alcohol is **NOT** approved.

Two Stroke Oil - A two-stroke engine oil meeting ISO-L-EGD (ISO/CD 13738) and J.A.S.O. FC Standards must be used. Echo brand premium Power Blend™ Universal 2-Stroke Oil meets these standards. Engine problems due to inadequate lubrication caused by failure to use an ISO-L-EGD and J.A.S.O. FC certified oil, such as Echo premium Power Blend™, will void the two-stroke engine warranty. (Emission related parts only are covered for two years, regardless of two-stroke oil used, per the statement listed in the Emission Defect Warranty Explanation.)

IMPORTANT

Echo premium Power Blend™ Universal 2-Stroke Oil may be mixed at 50:1 ratio for application in all Echo engines sold in the past regardless of ratio specified in those manuals.

Handling Fuel

WARNING DANGER

Fuel is VERY flammable. Use extreme care when mixing, storing or handling or serious personal injury may result.

- Use an approved fuel container.
- DO NOT smoke near fuel.
- DO NOT allow flames or sparks near fuel.
- Fuel tanks/cans may be under pressure. Always loosen fuel caps slowly allowing pressure to equalize.
- NEVER refuel a unit when the engine is HOT or RUNNING!
- DO NOT fill fuel tanks indoors. ALWAYS fill fuel tanks outdoors over bare ground.
- DO NOT overfill fuel tank. Wipe up spills immediately.
- Securely tighten fuel tank cap and close fuel container after refueling.
- Inspect for fuel leakage. If fuel leakage is found, do not start or operate unit until leakage is repaired.
- Move at least 3m (10 ft.) from refueling location before starting the engine.

Fuel to Oil Mix - 50:1 Ratio

U.S.		METRIC	
GAS	OIL	GAS	OIL
Gallons	Fl. oz.	Liter	cc.
1	2.6	4	80
2	5.2	8	160
5	13	20	400

Mixing Instructions

1. Fill an approved fuel container with half of the required amount of gasoline.
2. Add the proper amount of 2-stroke oil to gasoline.
3. Close container and shake to mix oil with gasoline.
4. Add remaining gasoline, close fuel container, and remix.

IMPORTANT

Spilled fuel is a leading cause of hydrocarbon emissions. Some states may require the use of automatic fuel shut-off containers to reduce fuel spillage.

After use

- DO NOT store a unit with fuel in its tank. Leaks can occur. Return unused fuel to an approved fuel storage container.

Storage - Fuel storage laws vary by locality. Contact your local government for the laws affecting your area. As a precaution, store fuel in an approved, airtight container. Store in a well-ventilated, unoccupied building, away from sparks and flames.

IMPORTANT

Stored fuel ages. Do not mix more fuel than you expect to use in thirty (30) days, ninety (90) days when a fuel stabilizer is added.

IMPORTANT

Stored two-stroke fuel may separate. ALWAYS shake fuel container thoroughly before each use.

STARTING COLD ENGINE

WARNING DANGER

The attachment will operate immediately when the engine starts and could result in loss of control and possible serious injury. Keep movable parts of the attachment off the ground and away from objects that could become entangled or thrown.

1. Stop Switch

Move stop switch button (A) away from the STOP position.

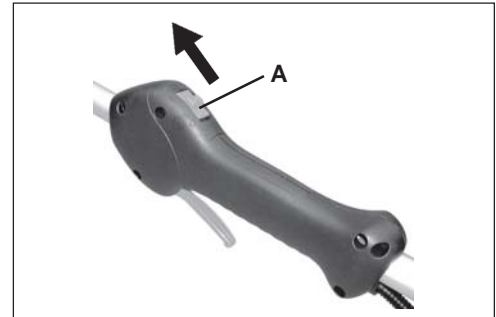

2. Choke

Move choke (B) to “Cold Start” () Position.

3. Purge Bulb

Pump purge bulb (C) until fuel is visible and flows freely in the clear fuel tank return line. Pump bulb an additional 4 or 5 times.

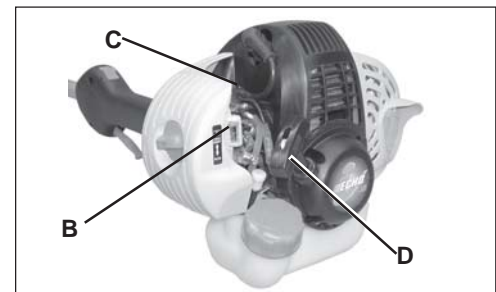

4. Recoil Starter

Lay the unit on a flat area and keep movable attachment parts clear of all obstacles. Firmly grasp right hand grip with left hand and fully depress throttle trigger to wide open position. Rapidly pull recoil starter handle/rope (D) until engine fires (or maximum five [5] pulls).



5. Choke

After engine fires or five (5) pulls, move choke lever (B) back to “Run” () position. Hold throttle trigger fully depressed and pull recoil starter handle/rope until engine starts and runs. Allow engine to run at partial throttle for approximately 10 seconds. Release throttle trigger and allow unit to warm up at idle for several minutes.

NOTE

If engine does not start with choke in “Run” position after 5 pulls, repeat instructions.

6. Throttle

After engine warm up, gradually depress throttle trigger to increase engine RPM to operating speed.



STARTING WARM ENGINE

The starting procedure is the same as Cold Start except DO NOT close the choke, and do not depress throttle trigger to wide open position.

WARNING DANGER

The attachment should not move at idle, otherwise serious personal injury may result.

NOTE

If attachment moves, readjust carburetor according to “Carburetor Adjustment” instructions in this manual or see your ECHO Dealer.

1. *Stop Switch*
Move stop switch button (A) away from the STOP position.
2. *Purge Bulb*
Pump purge bulb (C) until fuel is visible and flows freely in the clear fuel tank return line. Pump bulb an additional 4 or 5 times.
3. *Recoil Starter*
Lay the unit on a flat area and keep movable attachment parts clear of all obstacles. Rapidly pull recoil starter handle/rope (D) until engine fires.

NOTE

If engine does not start after 5 pulls, use Cold Start Procedure.

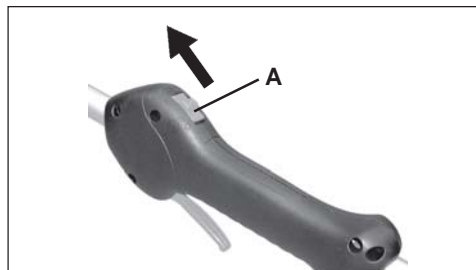

STOPPING ENGINE

1. *Throttle*
Release throttle and allow engine to return to idle before shutting off engine.
2. *Stop Switch*
Move stop switch button (A) backward to STOP position.

WARNING DANGER

If engine does not stop when stop switch is moved to STOP position, close choke (B) - COLD START position - to stall engine. Have your ECHO dealer repair stop switch before using trimmer again.

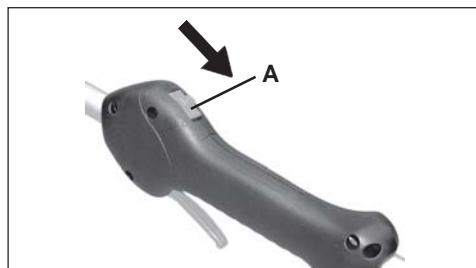

MAINTENANCE

Your ECHO trimmer is designed to provide many hours of trouble free service. Regular scheduled maintenance will help your trimmer achieve that goal. If you are unsure or are not equipped with the necessary tools, you may want to take your unit to an ECHO Service Dealer for maintenance. To help you decide whether you want to DO-IT-YOURSELF or have the ECHO Dealer do it, each maintenance task has been graded. If the task is not listed see your Echo dealer for repairs.

SKILL LEVELS

- Level 1** = Easy to do. Most required tools come with unit.
- Level 2** = Moderate difficulty. Some specialized tools may be required.
- Level 3** = Experience required. Specialized tools are required. ECHO recommends that the unit be returned to your ECHO dealer for servicing.

ECHO offers **REPOWER™** Maintenance Kits and Parts to make your maintenance job easier. Just below each task heading are listed the various part numbers required for that task. See your ECHO dealer for these parts.

MAINTENANCE INTERVALS

COMPONENT/ SYSTEM	MAINTENANCE PROCEDURE	REQ'D SKILL LEVEL	DAILY OR BEFORE USE	EVERY REFUEL	3 MONTHS OR 90 HOURS	6 MONTHS OR 270 HOURS	YEARLY 600 HOURS
Recommended Echo Dealer Maintenance Procedures							
Cylinder Exhaust Port	Inspect/Clean/Decarbon	3			I / C		
Do-It-Yourself Maintenance Procedures							
Air Filter	Inspect/Clean/Replace	1	I / C		R*		
Choke	Inspect/Clean	2	I / C				
Fuel Filter	Inspect/Replace	1			I		R *
Fuel System, Leaks	Inspect/Replace	1	I	I / R *			
Cooling System	Inspect/Clean	2	I / C				
Muffler Spark Arrestor	Inspect/Replace	2			I / R *		
Drive Shaft	Grease	2					I (1)
Recoil Starter Rope	Inspect/Clean	1	I / C *				I / R *
Spark Plug	Inspect/Clean	2			I / C	R *	
Screws/Nuts/Bolts	Inspect/Tighten/Replace	1	I / R *				

MAINTENANCE PROCEDURE LETTER CODES: I = INSPECT, R = REPLACE, C = CLEAN

IMPORTANT NOTE - Time intervals shown are maximum. Actual use and your experience will determine the frequency of required maintenance.

MAINTENANCE PROCEDURE NOTES:

* All recommendations to replace are based on the finding of damage or wear during inspection.

(1) Apply ECHO® LUBE™ yearly.

AIR FILTER

Level 1.

Tools required: 25 or 50 mm (1 or 2 in.) Cleaning brush

Parts required: 90008 REPOWER™ Air and Fuel Filter Kit

1. Close choke (Cold Start Position (☞)). This prevents dirt from entering the carburetor throat when the air filter is removed. Brush accumulated dirt from the air filter area.
2. Remove the air filter cover. Lightly brush debris from filter. If filter is fuel soaked, deformed, or very dirty, replace it.
3. If filter can be reused, be certain it:
 - fits tightly in the air filter cavity.
 - is installed with the original side out.

NOTE

Carburetor adjustment may be needed after air filter cleaning/ replacement. See Carburetor Adjustment Section.

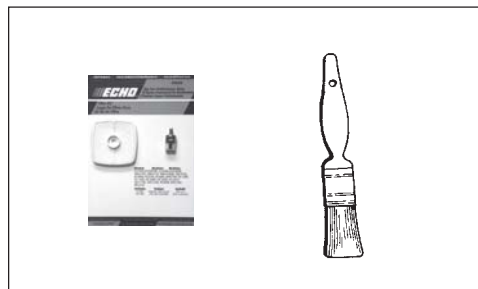

FUEL FILTER

Level 1.

Tools required: 200-250 mm (8 - 10 in.) length of wire with one end bent into a hook, clean rag, funnel, and an approved fuel container.

Parts required: 90008 REPOWER™ Air and Fuel Filter Kit

WARNING DANGER

Fuel is **VERY** flammable. Use extreme care when mixing, storing or handling.

1. Use a clean rag to remove loose dirt from around fuel cap and empty fuel tank.
2. Use the “fuel line hook” to pull the fuel line and filter from the tank.
3. Remove the filter from the line and install the new filter.



SPARK PLUG

Level 2.

Tools Required: T-Wrench, feeler gauge, soft metal brush

Parts Required: REPOWER™ Tune-Up Kit P/N90074C

IMPORTANT

Use only NGK BPM-8Y spark plug (BPMR-8Y in Canada) otherwise severe engine damage may occur.

1. Remove spark plug and check for fouling, worn and rounded center electrode.
2. Clean the plug or replace with a new one. DO NOT sand blast to clean. Remaining sand will damage engine.
3. Adjust spark plug gap by bending outer electrode.
4. Tighten spark plug to 150-170 kg/cm (130-150 in. lb.).

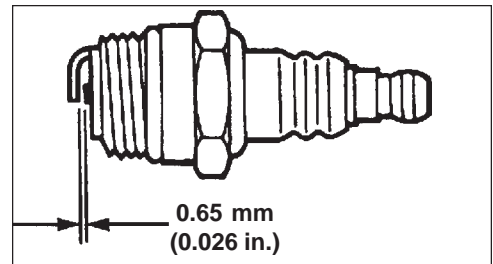
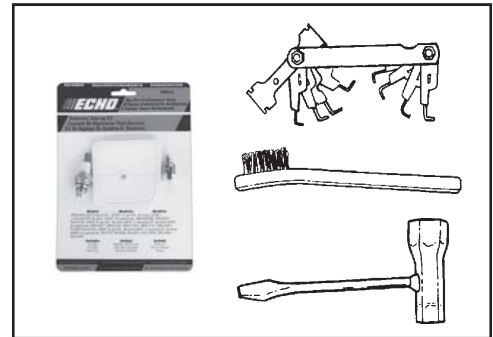

COOLING SYSTEM

Level 2.

Tools required: 3 & 4 mm Hex Wrench, 25 or 50 mm (1 or 2 in.) cleaning brush

Parts Required: None if you are careful.

IMPORTANT

To maintain proper engine operating temperatures, cooling air must pass freely through the cylinder fin area. This flow of air carries combustion heat away from the engine.

Overheating and engine seizure can occur when:

- Air intakes are blocked, preventing cooling air from reaching the cylinder.
- Dust and grass build up on the outside of the cylinder. This build up insulates the engine and prevents the heat from leaving.

Removal of cooling passage blockages or cleaning of cooling fins is considered "Normal Maintenance." Any failure attributed to lack of maintenance is not warranted.

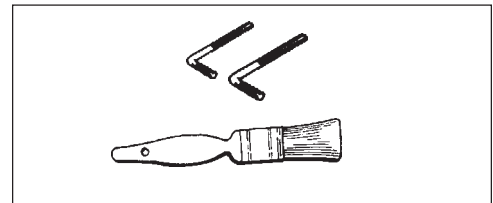

1. Remove spark plug lead (A).
2. Remove air filter cover (B).
3. Remove one (1) muffler cover screw and muffler cover (C).
4. Remove two (2) screw and engine cover (D).

IMPORTANT

DO NOT use a metal scraper to remove dirt from the cylinder fins.

5. Use brush to remove dirt from the cylinder fins.
6. Remove grass and leaves from the grid between the recoil starter and fuel tank.
7. Assemble components in reverse order.

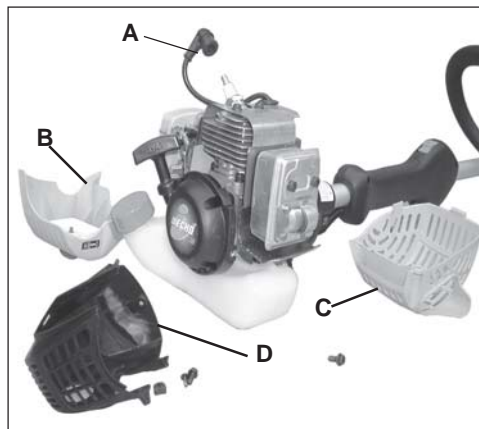

EXHAUST SYSTEM

Spark Arrestor Screen

Level 2.

Tools Required: Cross Head Screwdriver, Soft Metal Brush, 4 mm Hex Wrench

Parts Required: Spark Arrestor Screen, Gasket

1. Remove spark plug lead.
2. Remove one (1) muffler cover screw and muffler cover.
3. Place piston at Top Dead Center (TDC) to prevent carbon/dirt from entering cylinder.
4. Remove spark arrestor screen cover (A), gaskets (B), and screen (C) from muffler body.
5. Clean carbon deposits from muffler components.
6. Replace screen if it is cracked, plugged or has holes burned through.
7. Assemble components in reverse order.

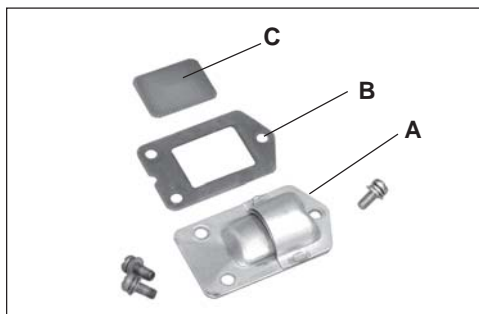
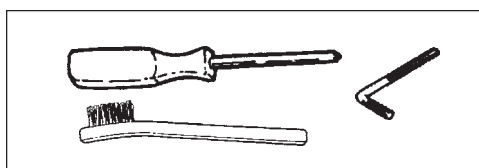

Cylinder Exhaust Port

Level 3.

IMPORTANT

The cylinder exhaust port must be inspected and cleaned of excess carbon every 3 months or 90 hours of operation in order to maintain this engine within the emissions durability period. ECHO strongly recommends that you return your unit to your ECHO dealer for this important maintenance service.

CARBURETOR ADJUSTMENT

Engine Break-In

New engines must be operated a minimum duration of two tanks of fuel break-in before carburetor adjustments can be made. During the break-in period your engine performance will increase and exhaust emissions will stabilize. Idle speed can be adjusted as required.

High Altitude Adjustment

High altitude adjustment is not required for proper operation of this engine.

Level 2.

Tools required: Screwdriver, tachometer (Echo P/N 99051130017)

Parts required: None.

NOTE

Do not adjust carburetor unless necessary. If you have difficulty, see your ECHO dealer.

Adjustment Screws

- | | |
|---------------------|---|
| Idle Speed (A) | Controls throttle opening at idle. |
| Low (LO) Speed (B) | Controls amount of fuel at low speed and supplementary fuel for smooth progression from idle to high speed. |
| High (HI) Speed (C) | Controls amount of fuel at full throttle |

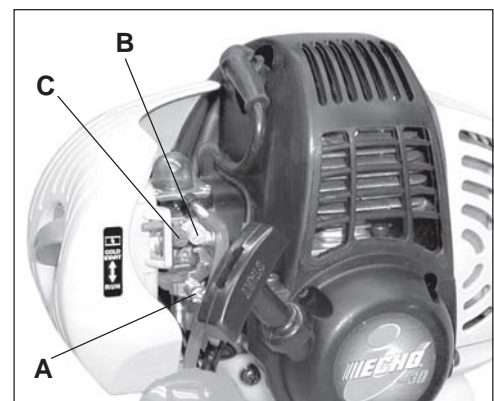
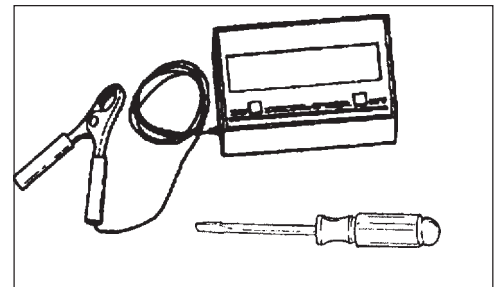

Before Adjustment

Check that:

- Air filter is clean and properly installed.
- Spark arrestor screen and muffler are free of carbon.
- Rapid Loader™ head with (2) new .080 x 8 in. lines is installed.

Initial Adjustment

1. With engine off, turn HI speed screw (C) counterclockwise to stop.
2. Turn LO speed screw (B) midway between stops.
3. Turn idle screw (A) until tip of screw just touches throttle plate; then turn three (3) turns clockwise.

Final Adjustment

IMPORTANT

Limiter caps prevent exceeding emission limits and over rich adjustment, but **not** over lean adjustment, which can cause engine failure: Do not exceed recommended HI speed engine R.P.M. during operation, or for long periods during adjustment.

1. Start engine, run at idle for one minute.
2. Complete warm up by running at full throttle for 5 minutes, operating choke twice to clear air from carburetor chambers.
3. Run at idle and accelerate to check for smooth transition from idle to high speed; if engine hesitates, turn LO speed screw (B) counterclockwise 1/8th of a turn at a time until acceleration is smooth.
4. Use a tachometer to adjust idle speed to specifications found on page 24.

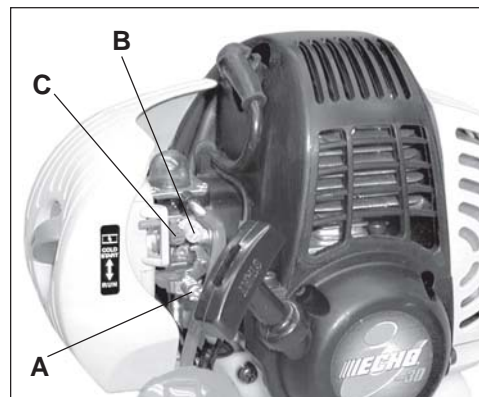

LUBRICATION

Level 1.

Tools Required: 8 mm Open-end wrench, screwdriver, clean rag

Parts Required: ECHO[®] LUBE[™] 8 oz. (P/N91014) or Lithium Base Grease

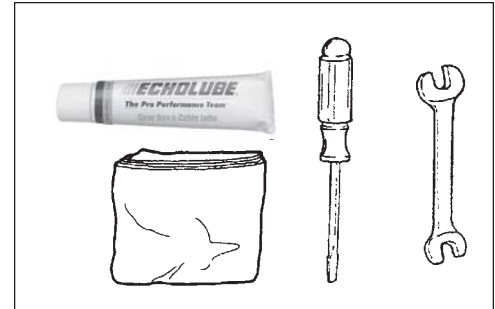

1. Remove plastic shield.
2. Loosen bearing housing locating screw (A), at the top of the housing, remove mounting screw (B).
3. Pull the flexible drive shaft (C) from the housing, wipe clean and re-coat with a thin coating 1/2 oz. (15 ml) of grease.
4. Slide the flexible drive shaft back in the drive housing being careful not to get dirt on the flexible drive shaft.
5. Install the bearing housing and shield.

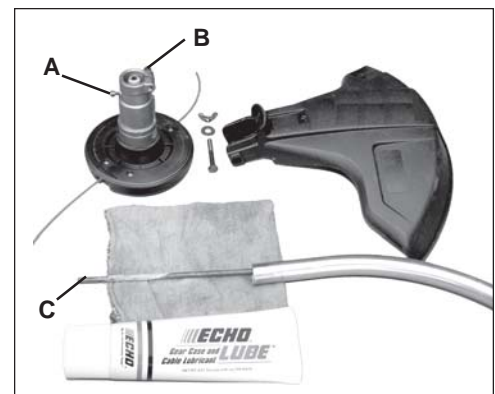

TROUBLESHOOTING

ENGINE PROBLEM TROUBLESHOOTING CHART				
Problem	Check	Status	Cause	Remedy
Engine cranks - starts hard/ doesn't start	Fuel at carburetor	No fuel at carburetor	Fuel strainer clogged Fuel line clogged Carburetor	Clean or replace Clean or replace See your Echo dealer
	Fuel at cylinder	No fuel at cylinder	Carburetor	See your Echo dealer
		Muffler wet with fuel	Fuel Mixture too rich	Open choke Clean/replace air filter Adjust carburetor See your Echo dealer
	Spark at end of plug wire	No spark	Stop switch off Electrical problem Interlock switch	Turn switch to ON See your Echo dealer See your Echo dealer
	Spark at plug	No spark	Spark gap incorrect Covered with carbon Fouled with fuel Plug defective	Adjust to .65mm (0.026 in.) Clean or replace Clean or replace Replace plug
Engine runs, but dies or does not accelerate properly	Air filter	Air filter dirty	Normal wear	Clean or replace
	Fuel filter	Fuel filter dirty	Contaminants/residues in fuel	Replace
	Fuel vent	Fuel vent plugged	Contaminants/residues in fuel	Clean or replace
	Spark Plug	Plug dirty/worn	Normal wear	Clean and adjust or replace
	Carburetor	Improper adjustment	Vibration	Adjust
	Cooling System	Cooling system dirty/plugged	Extended operation in dirty/dusty locations	Clean
	Spark Arrestor Screen	Spark arrestor screen plugged	Normal wear	Replace
Engine does not crank	N/A	N/A	Internal engine problem	See your Echo dealer

WARNING  DANGER

Fuel vapors are **extremely** flammable and may cause fire and/or explosion. **Never** test for ignition spark by grounding spark plug near cylinder plug hole, otherwise serious personal injury may result.

STORAGE

Long Term Storage (over 30 days)

WARNING  **DANGER**

During operation the muffler or catalytic muffler and surrounding cover become hot. Always keep exhaust area clear of flammable debris during transportation or when storing, otherwise serious property damage or personal injury may result.

Do not store your unit for a prolonged period of time (30 days or longer) without performing protective storage maintenance which includes the following:

1. Store unit in a dry, dust free place, out of the reach of children.

WARNING  **DANGER**

Do not store in enclosure where fuel fumes may accumulate or reach an open flame or spark.

2. Place the stop switch in the "OFF" position.
3. Remove accumulation of grease, oil, dirt and debris from exterior of unit.
4. Perform all periodic lubrication and services that are required.
5. Tighten all the screws and nuts.
6. **Drain** the fuel tank **completely** and pull the recoil starter handle several times to remove fuel from the carburetor.
7. Remove the spark plug and pour 7 cc (1/4 oz.) of fresh, clean, two-stroke engine oil into the cylinder through the spark plug hole.
 - A. Place a clean cloth over the spark plug hole.
 - B. Pull the recoil starter handle 2-3 times to distribute the oil inside the engine.
 - C. Observe the piston location through the spark plug hole. Pull the recoil starter handle slowly until the piston reaches the top of it's travel and leave it there.
8. Install the spark plug (do not connect spark plug cable).

SPECIFICATIONS

MODEL	GT-251E
Length	1,510mm(59.4in.)
Width	315mm(12.4in.)
Height	545mm(21.5in.)
Weight (dry) w/Cutter Head (GT251E)	4.77kg (10.5lb.)
Engine Type	Air cooled, two-stroke, single cylinder gasoline engine
Bore	34.0mm(1.34in.)
Stroke	28.0mm(1.10in.)
Displacement	25.4 cc (1.55 cu. in.)
Exhaust(GT-251E)	Spark Arrestor Muffler
Carburetor	Zama diaphragm w/purge
Ignition System	Flywheel magneto, capacitor discharge ignition
Spark Plug	NGK BPMR-8Y 0.65 mm(0.026in.)
Fuel	Mixed (Gasoline and Two-stroke Oil)
Fuel/Oil Ratio	50:1 two-stroke air cooled engine oil
Gasoline	89 Octane unleaded. DO NOT use fuel containing methyl alcohol, more than 10% ethyl alcohol or 15% MTBE.
Oil	Power Blend™ Premium Universal 2-Stroke Oil
Fuel Tank Capacity	0.40lit. (13.5 US fl. oz.)
Recoil Starter System	i-30 Automatic Recoil Starter
Clutch	Centrifugal Type
Drive Shaft	6.35 mm(1/4 in.) Flex Shaft
Rotating Direction	Clockwise viewed from top
Cutter Head	Rapid Loader™ 2-line Head with .080 in. (12 pieces)
Handle	Left - D-Loop, Right - Grip
Shoulder Harness	Optional 99944200201
Idle Speed (RPM)	2,500-3,000
Wide Open Throttle Speed with Trimmer Head (RPM)	7,300-9,300

IMPORTANT

This spark ignition system complies with Canadian ICES-002

NOTES

NOTES

NOTES

SERVICING INFORMATION

PARTS/SERIAL NUMBER

Genuine ECHO Parts and ECHO REPOWER™ Parts and Assemblies for your ECHO products are available only from an Authorized ECHO Dealer. When you do need to buy parts **always** have the Model Number and Serial Number of the unit with you. You can find these numbers on the engine housing. For future reference, write them in the space provided below.

Model No. _____ SN. _____

SERVICE

Service of this product during the warranty period must be performed by an Authorized ECHO Service Dealer. For the name and address of the Authorized ECHO Service Dealer nearest you, ask your retailer or call: 1-800-432-ECHO (3246). Dealer information is also available on our Web Site. When presenting your unit for Warranty service/repairs, proof of purchase is required.

ECHO CONSUMER PRODUCT SUPPORT

If you require assistance or have questions concerning the application, operation or maintenance of this product you may call the ECHO Consumer Product Support Department at 1-800-673-1558 from 8:30 am to 4:30 pm (Central Standard Time) Monday through Friday. Before calling, please know the model and serial number of your unit to help your Consumer Product Support Representative.

WARRANTY REGISTRATION

You may register your Echo equipment using the warranty registration card or register on-line at www.echo-usa.com. Registering provides a direct link between you and ECHO if we find it necessary to contact you.

ADDITIONAL OR REPLACEMENT MANUALS

Safety Manuals in English/Spanish or English/French are available, free of charge, from your ECHO dealer or at www.echo-usa.com.

Operator's and Parts Manuals are available by:

- Downloading free from www.echo-usa.com
- Purchasing from your Echo Dealer.
- Manuals are available by sending a written request stating the model number and serial number of your Echo unit, part number of the manual, your name and address, and mail to the address below.

Safety Videos are available from your Echo dealer. A \$5.00 shipping charge will be required for each video.



DEALER?

Call
1-800-432-ECHO
or
www.echo-usa.com

CONSUMER PRODUCT SUPPORT

1-800-673-1558
8:30 - 4:30 Mon - Fri C.S.T.



ECHO®

ECHO, INCORPORATED
400 OAKWOOD ROAD
LAKE ZURICH, IL 60047-1564

WWW.ECHO-USA.COM

10001001/10999999